

DISC CERAMIC CAPACITORS

ELECTRICAL SPECIFICATIONS

Capacitance Range: 10pF to 100000pF

CLASS : Tested at 1.0±0.2V RMS, +25 and 1MHz.

CLASS 、 : Tested at 1.0±0.2V RMS, +25 and 1KHz.

Capacitance Tolerance:

J=±5% (Except for Y5E/Y5P & Y5V/Y5U & Z5V)

K=±10% (Except for Y5V/Y5U & Z5V)

M=±20% (Except for Z5V)

Z=+80%-20%

P=+100%-0%

Working Voltage: 16V 25V 50V 100V 250V

500, 1000, 2000, 3000, 4000, 5000, 6000,...15KV

Dielectric Strength:

Below 1KV: 250% rated voltage with 50mA max charging current.

1KV & above: 200% rated voltage with 50mA max charging current.

10KV & above: 150% rated voltage with 50mA max charging current.

Dissipation Factor:

CLASS : Tested at 1.0±0.2V RMS, +25 and 1MHz 30PF below Q>400+20*Cap 30pf above Q 1000.

CLASS 、 : Tested at 1.0±0.2V RMS, +25 and 1KHz, 3% max for Z5V, 2.5% max for others.

Insulation Resistance:

10,000 Megohms min at rate working voltage or 500VDC whichever is less. @ 25

Humidity Test:

Per EIA RS-198-C, method B3, Condition B. Capacitance Change: 30% max for Z5V, 20% max for others.

Dissipation Factor: 5% max for Z5V, 3% max for others.

Life Test:

Per EIA RS-198-C, method C2, Condition C, at 85±2 , and 200% rated working voltage. (150% for parts rated over 500VDC).

Capacitance Change: 30% max for Z5V, 20% max for others.

Dissipation Factor: 5% max for Z5V, 3% max for others. **Insulation Resistance:** 10,000 Megohms min.

DISC CERAMIC CAPACITORS

TEMPERATURE DEPENDENCY OF CAPACITANCE

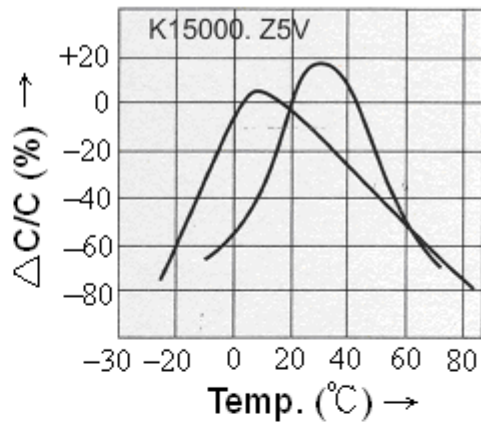
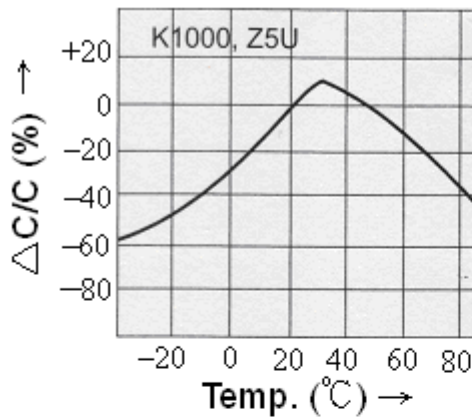
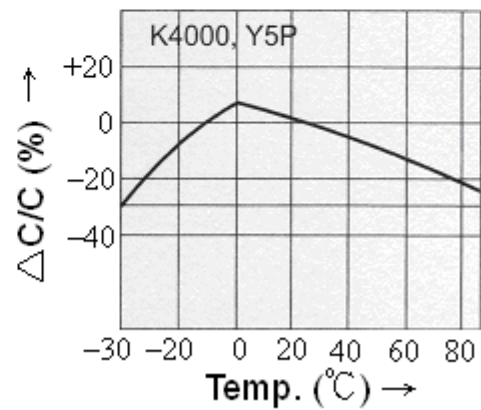
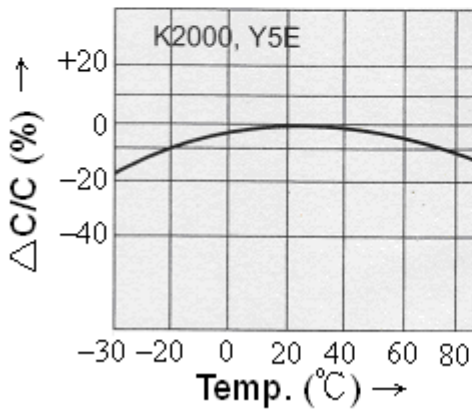
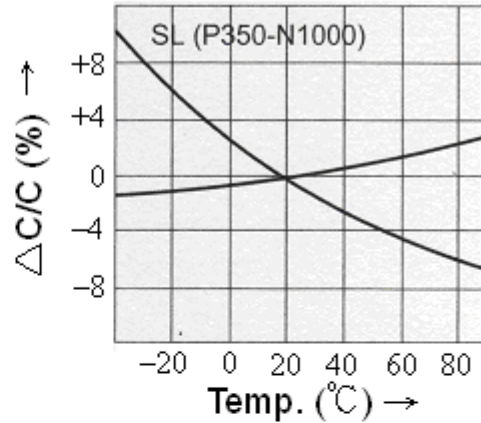
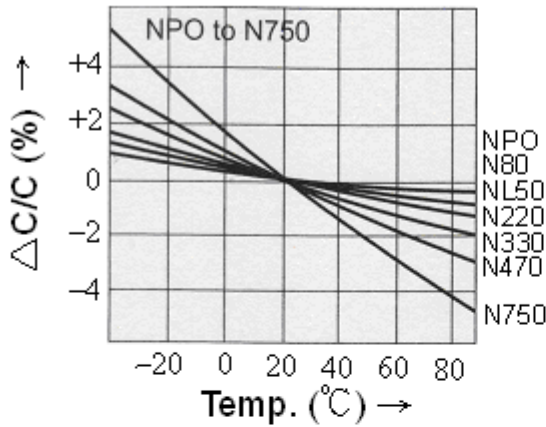

ΔCAPACITANCE VS. FREQUENCY

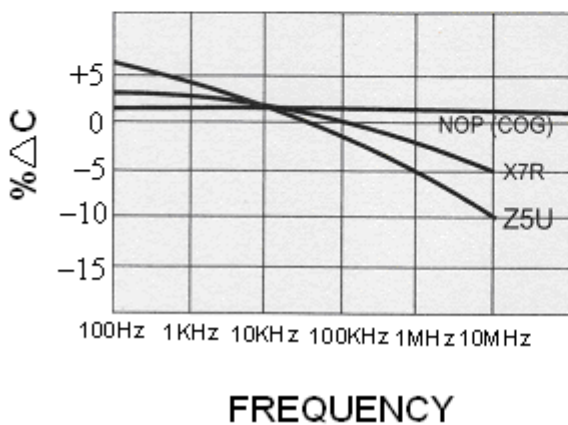

DF AND Q

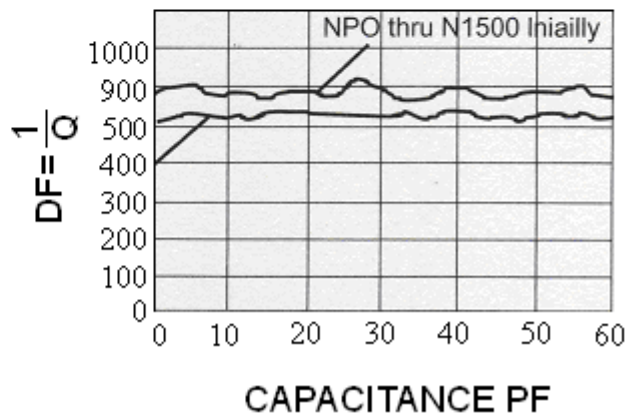

DISC CERAMIC CAPACITORS

HOW TO ORDER

PARTS NUMBER SYSTEM

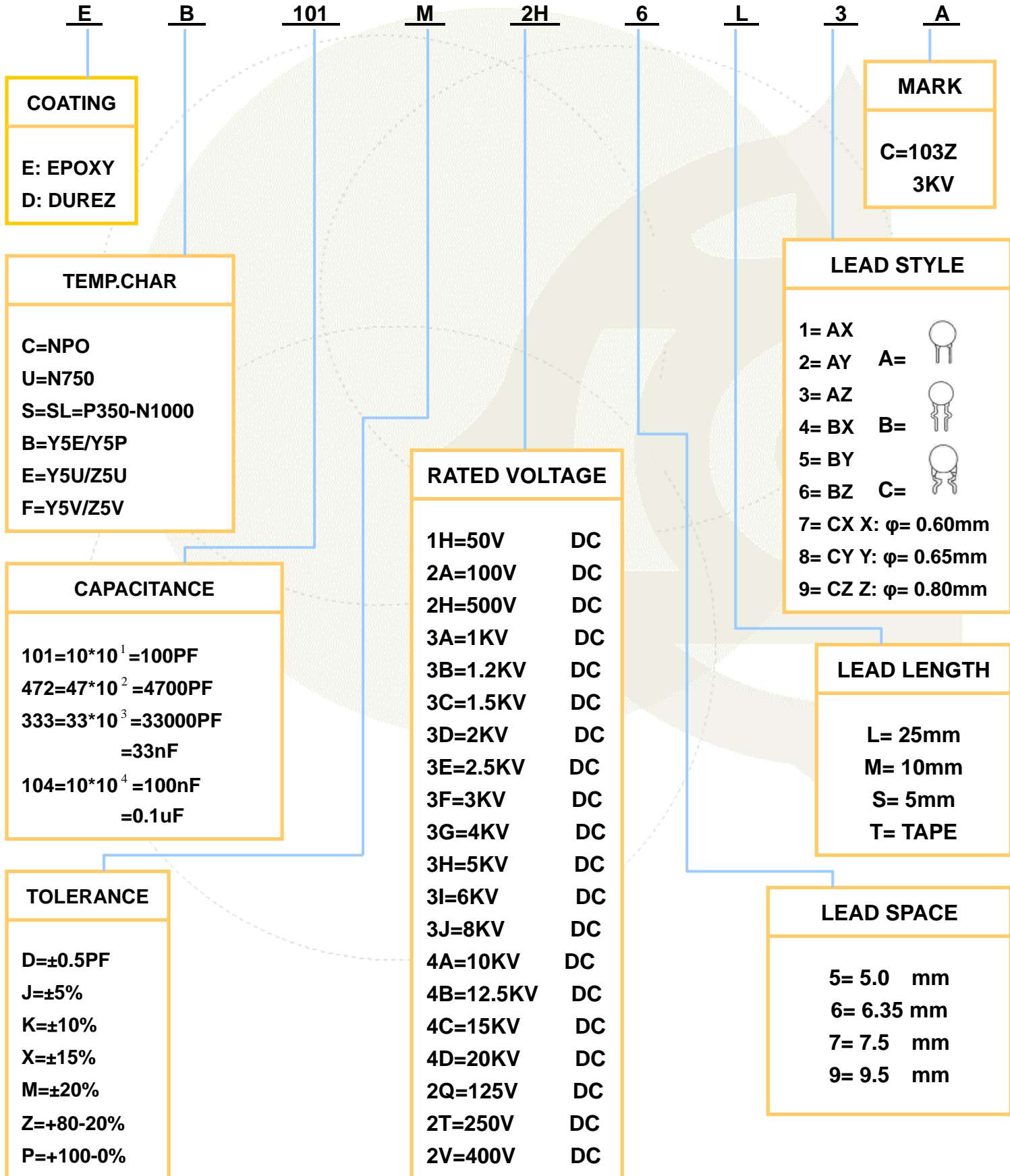

DISC CERAMIC CAPACITORS

DIMENSION OF D-C HIGH VOLTAGE DISC CAPACITORS

CLASS

W.V.DC.	T.C.	C (NPO)	U (N750)	S (SL)	DIAMETER (MAX)
50V		1PF-50PF	22PF-50PF	47PF-150PF	5
		51PF-82PF	51PF-82PF	180PF-220PF	6
		83PF-120PF	83PF-120PF	250PF-330PF	8
		121PF-180PF	130PF-180PF	340PF-470PF	9
		181PF-220PF	181PF-220PF	500PF-680PF	10
		221PF-270PF	221PF-270PF	820PF	11
		271PF-330PF	271PF=330PF	---	12
		340PF-390PF	301PF-331PF	---	13
		470PF	470PF	---	15

CLASS

W.V.DC.	T.C.	B (Y5P, Y5E)	E (Z5U)	F (Z5V)	DIAMETER (MAX)
50V		270PF-2200PF	2000PF-5000PF	5000PF-10000PF	6
		2300PF-3300PF	6800PF-8200PF	10000PF-20000PF	7
		3400PF-5000PF	10000PF-12000PF	22000PF	8
		5100PF-6800PF	15000PF		9
		8200PF-10000PF	18000PF-20000PF		10
		10000PF	22000PF	47000PF	11

CLASS

W.V.DC.	T.C.	E (Y5U)	F (Y5V)	DIAMETER (MAX)
50V		33000PF	47000PF	6
		47000PF	100000PF	7
		68000PF		8
		100000PF		9

DISC CERAMIC CAPACITORS

DIMENSION OF D-C HIGH VOLTAGE DISC CAPACITORS

W.V.DC. \ T.C.	B (Y5E, Y5P)	E (Z5U, Y5U)	F (Z5V)	DIAMETER (MAX)
500V	150PF-680PF	1000PF	2200PF	5
	1200PF	1500PF	4700PF	6-7
	1500PF	2200PF	6800PF	7
	2200PF	4700PF	10000PF	8-9
	3300PF	10000PF	15000PF	9
	4700PF	---	20000PF	10
	10000PF	20300PF	33000PF	14
	---	33000PF	47000PF	18
1KV	100PF-470PF	1000PF	1000PF	5
	560PF-820PF	1500PF-2200PF	1500PF-2200PF	6
	1000PF	3300PF	4700PF	7
	1500PF	3900PF	6800PF	8
	2200PF	4700PF	10000PF	9
	3300PF	10000PF	15000PF	10
	4700PF	15000PF	22000PF	12
	6800PF	22000PF	33000PF	14
	8200PF	33000PF	47000PF	16
	10000PF	47000PF	100000PF	20
2KV	100PF-470PF	---	1000PF	4-6
	560PF	1000PF	2200PF	6-7
	820PF	1500PF	3300PF	9
	1000PF	2200PF	4700PF	5-10
	2200PF	3300PF	6800PF	10
	3300PF	4700PF	8200PF	12
	4700PF	6800PF-8200PF	10000PF	14
	5600PF-6800PF	10000PF	22000PF	16
	8200PF	---	---	20
	10000PF	22000PF	47000PF	20

DISC CERAMIC CAPACITORS

DIMENSION OF D-C HIGH VOLTAGE DISC CAPACITORS

W.V.DC.	T.C.	B (Y5E, Y5P)	E (Z5U, Y5U)	F (Z5V)	DIAMETER (MAX)
3KV		100PF-330PF	---	1000PF	5 -7
		390PF-470PF	1000PF	1500PF	4 -8
		680PF	1500PF	2200PF	6 -8
		820PF-1000PF	2200PF	3300PF	5 -10
		1500PF	3300PF	4700PF	10
		1800PF	4700PF	5600PF	12
		2000PF-2700PF	5600PF	10000PF	14
		3300PF-3900PF	6800PF	---	16
		4700PF	8200PF-10000PF	22000PF	18
4KV		100PF-270PF	---	1000PF	8
		330PF-560PF	1000PF	1500PF	9
		680PF-820PF	1500PF	2200PF	10
		1000PF	---	---	11
		1200PF	2200PF	3300PF	12
		1500PF	3300PF	4700PF	14
		2200PF	4700PF	5600PF	16
		---	6800PF	---	18
		3300PF	8200PF	10000PF	20
	4700PF	10000PF	---	22	
5KV		220PF	---	---	8
		270PF-330PF	---	1000PF	9
		470PF	1000PF	---	10
		680PF	1500PF	1500PF	12
		1000PF	---	1800PF	13
		1500PF	1800PF	2200PF	15
		2200PF	2200PF	3300PF	18
	3300PF	---	---	22	

DISC CERAMIC CAPACITORS

LOW DF OF HIGH VOLTAGE DISC CAPACITORS

These medium HIGH-VOLTAGE ceramic capacitors have a primary of SrTiO_3 and provide low voltage distortion and piezoelectric effects as well as excellent.

TEMPERATURE, BIAS, and FREQUENCY CHARACTERISTICS.

This article that its Dissipation Factor $\leq 0.5\%$.

Insulation Resistance $\geq 10\text{G}$

Temperature Characteristics = Y5P

DIMENSION & CAPACITANCE RANGE

T.C. W.V.DC.	B TYPE (Y5P)	DIAMETER (MAX)
2KV	150PF-220PF	7
	390PF	8
	470PF-560PF	9
	820PF	10
	1000PF	11
	1200PF	12
	1500PF-1800PF	13
	2200PF-2700PF	15

TEMPERATURE DEPENDENCY OF CAPACITANCE

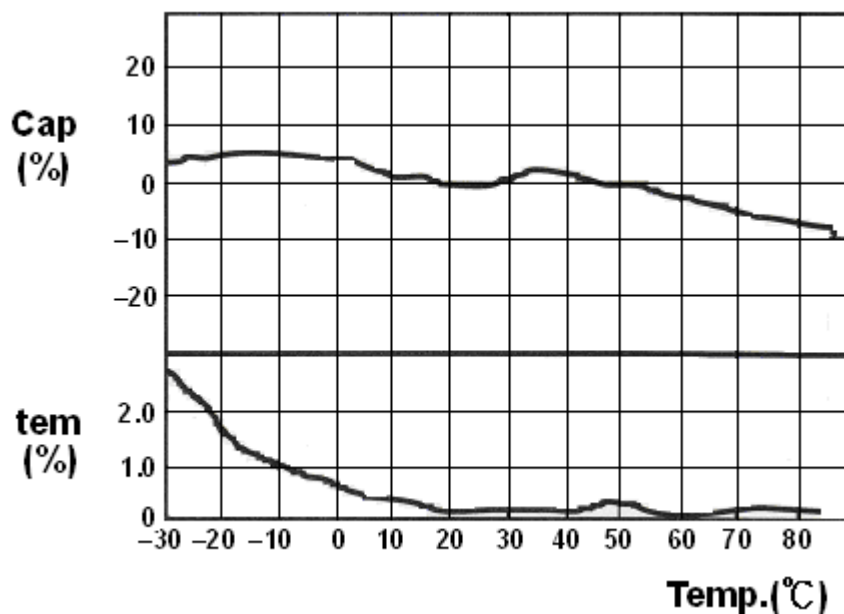

DISC CERAMIC CAPACITORS

SPECIAL LEAD TYPE OF DISC CAPACITORS

Dimensions (Unit Millimeter)

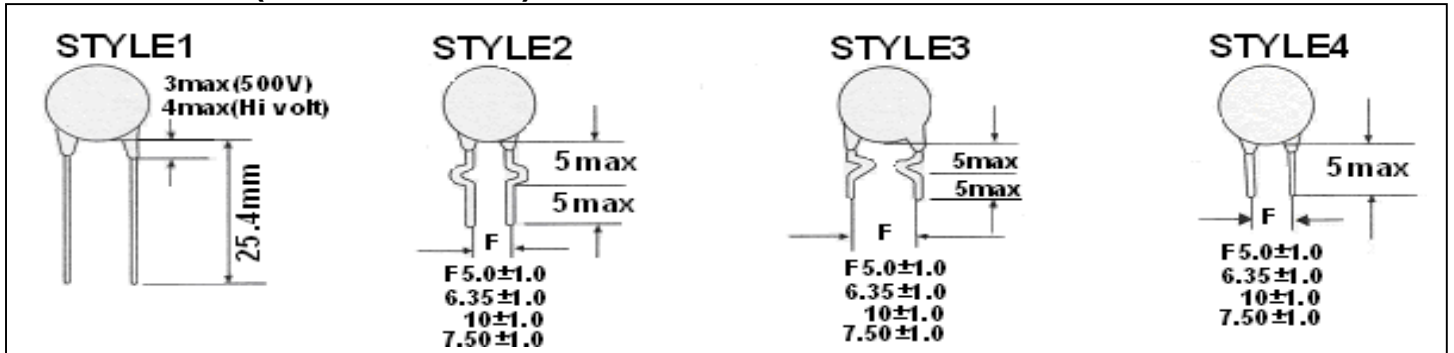

TAPING LEAD TAPING CAPACITORS FOR AUTOMATIC INSERTION

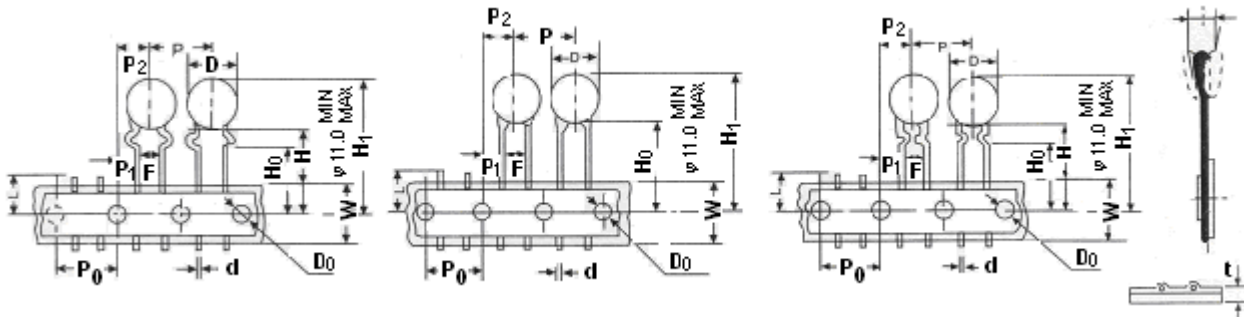

SYMBOL	D	d	P	P_0	P_1	P_2	F	H_0	H	H_1	D_0	W	L	t
VALUE	MAX 11.0	0.6	12.7	12.7	3.85	6.35	5.0	16.0 18.0	20	MAX 32 25	4.0	18.0	MAX 11.0	0.7
TOLERANCE	---	+0.06 -0.05	±1	±0.2	±0.7	±1.0	+0.8 -0.2	+1.5 -1.0	-1.5 -1.0	---	±0.2	±0.5	---	±0.2

PACKAGING QUANTITY:

PACKAGE	ONE BOX	CARTON BOX
REEL PACK	2,500 PCS	25,000PCS
ZIGZAG PACK	2,000 PCS	20,000PCS

REEL and BOX DIMENSIONS (mm)

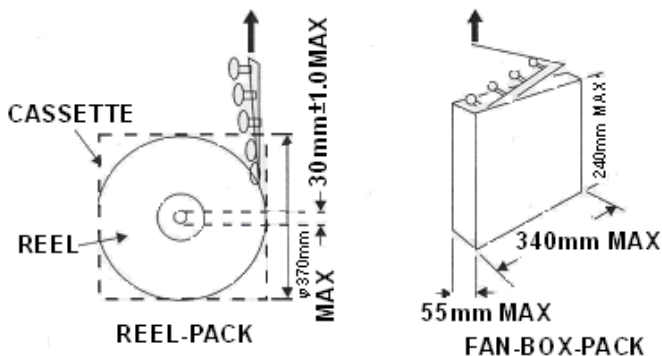

DISC CERAMIC CAPACITORS

ELECTRICAL SPECIFICATIONS

● Capacitance Range: 1pF to 10Uf

● Capacitance Tolerance: [Standare]

NPO:F= $\pm 1\%$

G= $\pm 2\%$

C= $\pm 0.25PF$ [10PF and below]

D= $\pm 0.5PF$ [10PF and below]

J= $\pm 5\%$ [10PF and above]

K= $\pm 10\%$ [5.6PF and above]

M= $\pm 20\%$ [2.7PF and above]

X7R: K= $\pm 10\%$

M= $\pm 20\%$

Z= +80-20%

Z5U: M= $\pm 20\%$

Z= +80-20%

Y5V: M= $\pm 20\%$

Z= +80-20%

● Working Voltage: 25, 50, 100, 200, 1K VDC

● Temperature Characteristic:

NPO: $0\pm 30ppm$, -55 to +125

X7R: $\pm 15\%$ C, -55 to +125

Z5U: +22% to -56% C, +10 to +85

Y5V: +22% to -82% C, -30 to +85

● Insulation Resistance

NPO, X7R: 100,000 megohms min. or 1000

ohm-Farads min., Whichever is less at 25

Z5U, Y5V: 10,000 megohms min. or 1000

ohm-Farads min., Whichever is less at 25

● MECHANICAL SPECIFICATION

Cast: Conformal coated [epoxy]

Lead Material: Solder coated, copper

Package Method: Bulk, Tape & Ammo Pack,

Solderability: [MIL-STD-202, Method 208]

Leach Resistance: Temp. 230 , 20 seconds

immersion in SN62

● STANDARD TOLERANCE

NPO: J.K.

X7R: K.M.

Z5U: M.Z.

Y5V: M.Z.

● Capacitance Test @ 25 or referred to +25 :

NPO, X7R:

1. 0VRMS \pm .25 VAMS and 1KHz;

1MHz for value below 100pF

Z5U, Y5V:

0.5 VRMS maximum and 1KHz.

● Dissipation Factor:

NPO: 0.1% maximum @ 25 . 1.0 VRMS \pm 25

VRM and 1KHz. 1MHz for values below 100pf.

X7R: 2.5% maximum @ 25 . 1.0 VRMS \pm 25

VRM and 1KHz.

Z5U: 4% maximum @ 25 . 0.5 VRMS

maximum and 1KHz.

Y5V: 7% maximum @ 25 . 1.0 VRMS

maximum and 1KHz.

● Dielectric Strength:

NPO, X7R: 250% rated voltage with 50 mA maximum charging current.

Z5U, Y5V: 200% rated voltage with 50 mA maximum charging current

● Life Test: (1000 hrs)

NPO and X7R: 200% rated voltage at +125

Z5U and Y5V: 150% rated voltage at +85

● Humidity Resistance: [MIL-STD-202 Method 106]

NPO, X7R, Z5U, Y5V: 96 hrs at 40 relative humidity 90~95%.

● Thermal Shock: [MIL-STD-202 Method 107, condition A]